

BASIC LINE

431 BASE

Stainless steel base composed of round cast iron ballast, stainless steel cover, stainless steel column in round sections, "star" cross in die-cast aluminum or dial in aluminum for glass tops.



STANDARD HEIGHTS

dimensions in millimeters

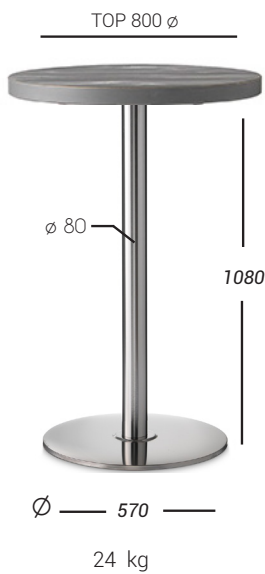

Standard steel finishes

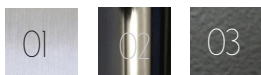

- * 01. Steel satin inox,
- 02. Steel polished chrome,
- 03. Orange peel black.

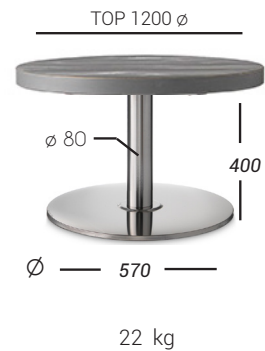

Special PF painting finishes

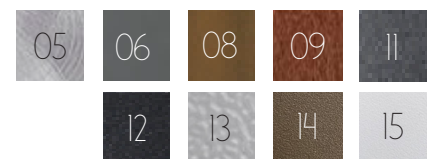

- * 05. Brushed industrial steel, 06. Wrinkle grey, 08. Corten, 09 Rust,
- 11. Graphite grey, 12. Carbon black, 13 Orange peel aluminium,
- 14. Wrinkle cappuccino, 15. Wrinkle white.

SOLID BEECH WOOD TUBE FOR 730 MM HIGH BASE

Standard wood finishes

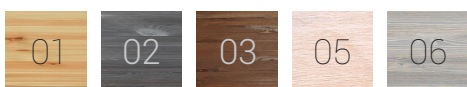

- 01. Natural, 02. coffe brown, 03. nutmeg,
- 05. white alabaster, 06. rock gray

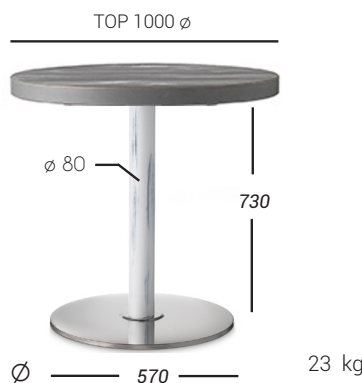

Special PF wood finishes



07. vintage

* see ['Warranty, maintenance and assistance'](#)

N.B: top measurements are indicative or recommended by PF STILE
 N.B: the industrial finishes are made with artisan procedures and there can be variations in color from production to production

THECNICAL FEATURES

- Painted ballest in cast iron
- Stainless steel cover, steel chrome or painted steel
- Stainless steel column, steel chrome or painted steel
- Star cross in die-cast aluminium
- Aluminium plate for glass tops
- 4 PE caps

EXTRAS

- Adjustable feet on request
 - Ral paint (any color)
 - Outdoor finishing *
 - Trasparent paint, anti-footprint, polyester powder paint
 - Single base cardboard packaging
- DREAM FOOTREST FOR BASE H 1080 MM

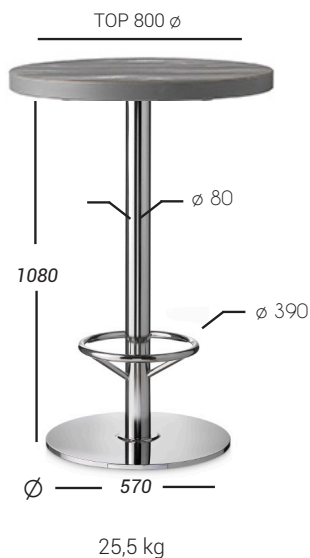

* see [Warranty, maintenance and assistance](#)

N.B: top measurements are indicative or recommended by PF STILE
N.B: the industrial finishes are made with artisan procedures and there can be variations in color from production to production